

PORTABLE STEEL DAVIT

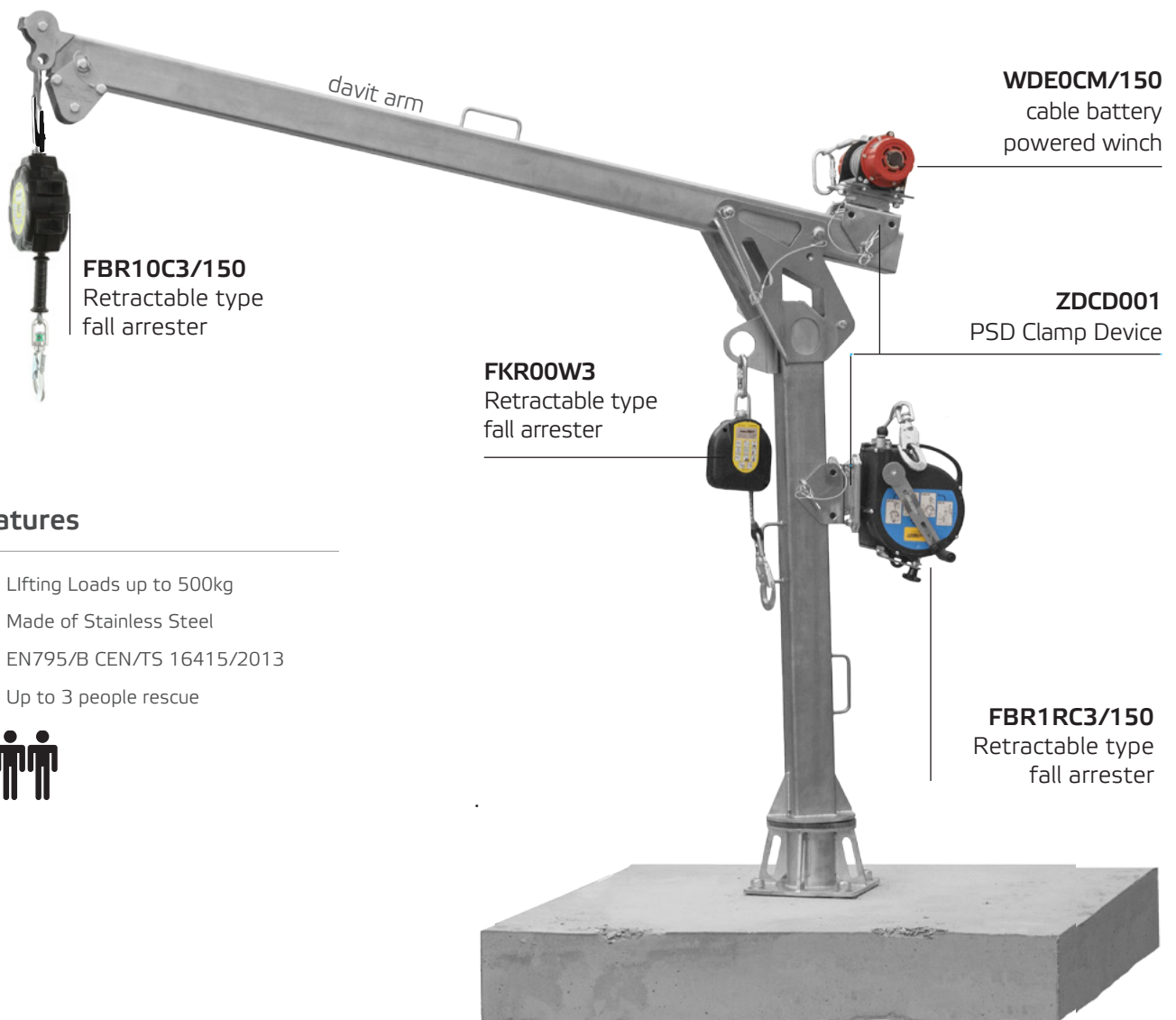

PORTABLE STEEL DAVIT - PSD

Portable Steel Davit Arm System, PSD is environment resistant, fully modular lifting and lowering device. Can be used for lifting loads up to 500kg (indicated on the davit arm) or for personal protection up to 3 people at the same time or for personal rescue operations using rescue lifting devices. PSD device is made of stainless steel.



Features

- Lifting Loads up to 500kg
- Made of Stainless Steel
- EN795/B CEN/TS 16415/2013
- Up to 3 people rescue



Example of Portable Steel Davit

COMPONENTS

ZDJ0150
Davit Arm 150cm

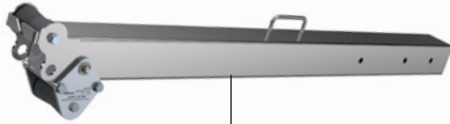

ZDJ0200
Davit Arm 200cm



ZDCB000
PSD Cover
Not included in basic set



ZDP0120
Davit Mast 120cm



ZDP0060
Davit Mast 60cm

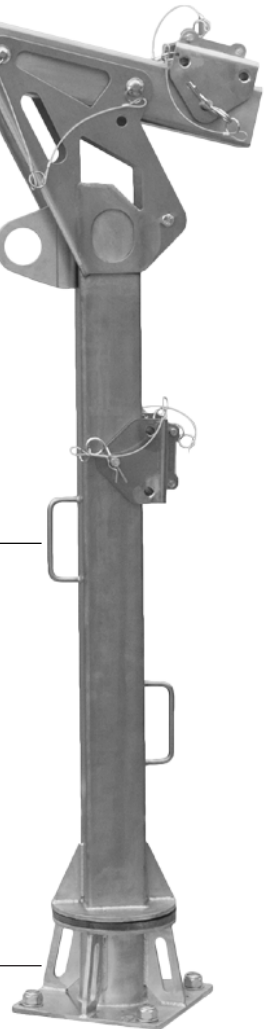

ZDWB000
Wall Bracket

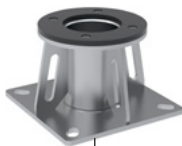

ZDFB000
Floor Bracket



ZDBB000
Barrel Bracket

DIMENSIONS

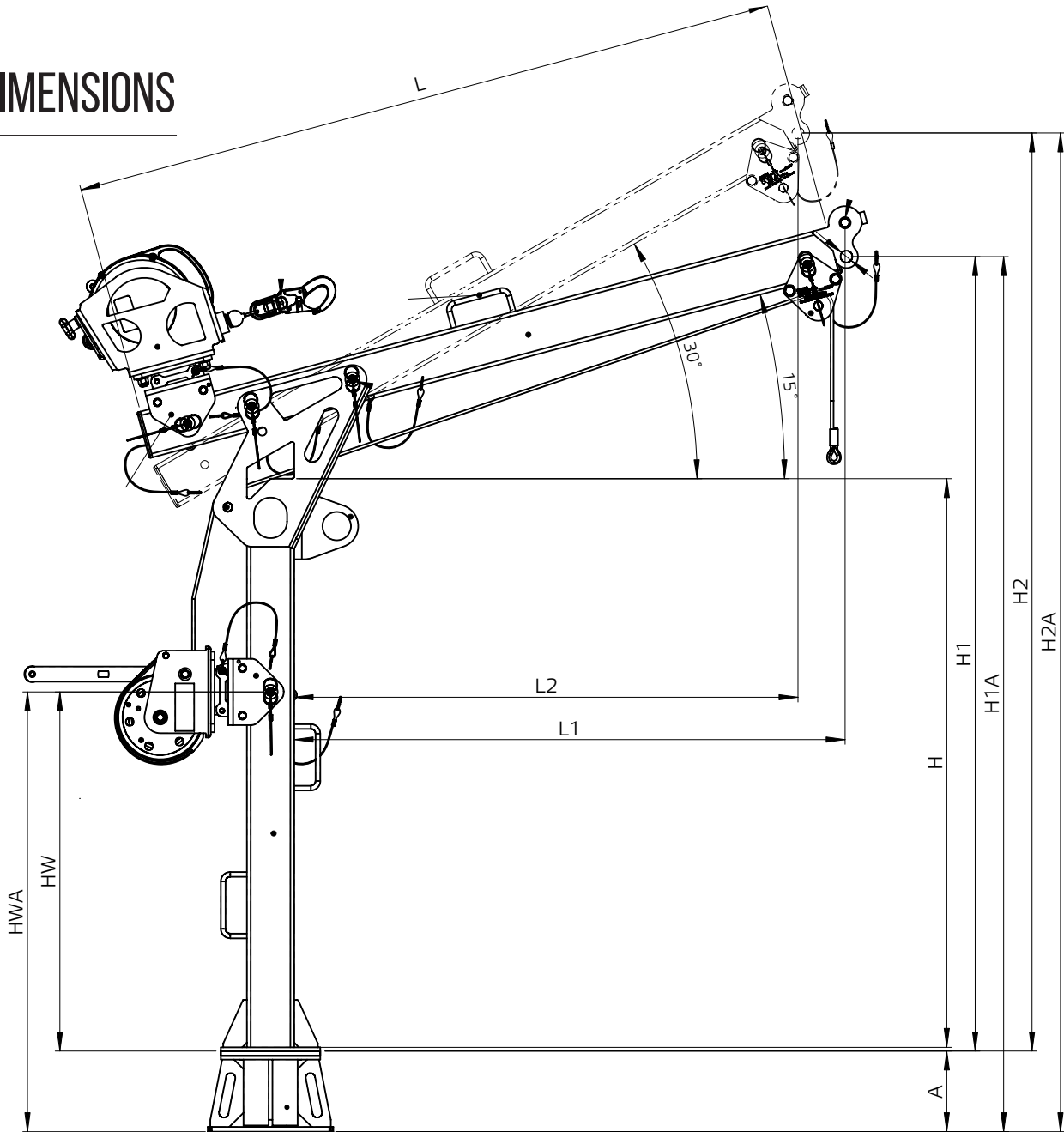

BRACKET	"A" [m]	Weight [kg]	MAST REF	"H" [m]	"HW" [m]	"HWA" [m]	Weight [kg]	ARM REF	"L" [m]	Weight [kg]	"L1" [m]	"L2" [m]	"H1" [m]	"H2" [m]
Wall Mounted	0.22	11.45	ZDP0060	0.6	0.36	0.58	18.06	ZDJ0150	1.5	20.7	1.16	1.06	1.08	1.34
							18.06	ZDJ0200	2.0	26.7	1.65	1.50	1.21	1.59
			ZDP0120	1.2	0.75	0.97	25.50	ZDJ0150	1.5	20.7	1.16	1.06	1.68	1.94
							25.50	ZDJ0200	2.0	26.7	1.65	1.50	1.81	2.19
Ground Mounted	0.17	10.66	ZDP0060	0.6	0.36	0.53	18.06	ZDJ0150	1.5	20.7	1.16	1.06	1.08	1.34
							18.06	ZDJ0200	2.0	26.7	1.65	1.50	1.21	1.59
			ZDP0120	0.6	0.75	0.92	25.50	ZDJ0150	1.5	20.7	1.16	1.06	1.68	1.94
							25.50	ZDJ0200	2.0	26.7	1.65	1.50	1.81	2.19

COMPATIBLE DEVICES

DESCEND

WD00CM/200 cable winch

The WD00CM/200 is a winch equipped with a clamp for mounting on tripod legs. The winch is equipped with 6 strand steel cable with natural fibre kern of 20 and 25m in length and 6.3mm in diameter; WD00CM/200 is a component of rescue equipment. The device, can be lifted from a lower level onto higher level or vice versa, the descent distance cannot be more than 2m. The ratio used in the mechanism; it is possible to make one turn of the drum per 5 turns of the winch's crank, The crank arm is available in 2 lengths which, depending of the variant chosen, enables torque adjustment.



WD00CM/200

+

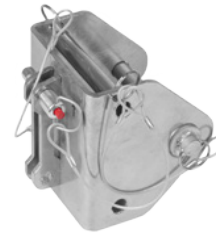

ZDC0000
Universal Bracket

Features

- Length of rope /weight 20m/13kg
- Diameter of rope 6.3mm
- Type of rope 6x19 + NFC
- Mechanism ratio 15
- Permissible work load: 140kg
- EN 1496/B

DESCEND PRO

WDP00CM/250 cable winch

The WDP00CM/250 is a winch equipped with a clamp for mounting on tripod legs. The winch is equipped with 6 strand steel cable with natural fibre kern of 25m, 35m, 45m and 50m in length and 6.3mm in diameter; WDP00CM/250 is a component of rescue equipment. The device, can be lifted from a lower level onto higher level or vice versa, the descent distance cannot be more than 2m. The ratio used in the mechanism; it is possible to make one turn of the drum per 7.2 turns of the winch's crank, The crank arm can be disassembled for easier transport. It complies with EN 1496/B.



WDP00CM/250

+

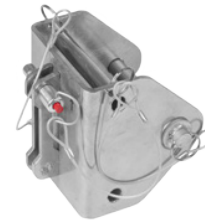

ZDC0000
Universal Bracket

Features

- Length of rope /weight 25m/22.5kg
- Diameter of rope 6.3mm
- Type of rope 6x19 + NFC
- Mechanism ratio 1:7.2
- Permissible work load: 200kg
- EN 1496/B

COMPATIBLE DEVICES

DESCEND ELECPRO

WDEPCM/300 cable single-phase 230V electric winch

The 230V AC 1-phase electric winch equipped with a wire rope of 6mm diameter and 30m length rolled on a drum, used to lift goods. Admissible working load while lifting goods (WLL): 500kg. If an additional pulley block system is used, the working load when lifting goods (WLL) can be increased to 1000kg. The device can be used to lift and descend people and to evacuate them when an additional self-holding device of the BLOCKMAX series is used. Admissible WLL: 200kg. A 230V 1-phase alternating power supply. The kit includes a cable for connection to the mains. Operating speed: 7m/min. The device is equipped with a tie plate as well as with a Universal Bracket ZDC000.



WDEPCM/300

ZDC0000 Universal Bracket

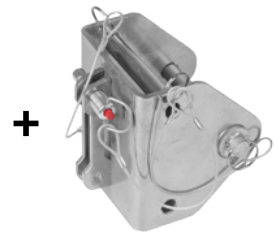

+

Features

- Length of rope/weight 30m/21kg
- Diameter of rope 6mm
- Type of rope steel
- Dimensions: 490 x 170 x 180mm
- Permissible work load: 500kg for cargo, 200kg for persons

DESCEND ELEC

WDPO0CM/250 cable battery powered winch

Electric battery winch equipped with a wire rope of 5mm diameter and 15m length, rolled on a drum, used to lift goods. Admissible working load while lifting goods (WLL): 140kg. If an additional pulley block system is used, the WLL can be increased to 250kg. The device can be used to lift and descend people and to evacuate them when an additional self-holding device of the BLOCKMAX series is used. Admissible working load when lifting/descending people (WLL): 140kg. Battery backup. The kit includes two 18V 4.0Ah batteries together with a charger. The battery life at full load equals 20...25 minutes. Operating speed 4m/min. The device is equipped with a tie plate as well as with a Universal Bracket.



WDPO0CM/250

ZDC0000 Universal Bracket

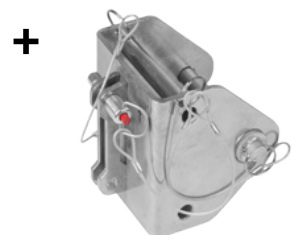

+

Features

- Length of rope/weight 15m/10kg
- Diameter of rope 5mm
- Type of rope steel
- Dimensions: 88 x 122 x 144mm
- Permissible work load: 140kg for cargo, 40kg for persons

COMPATIBLE DEVICES

BLOCKMAX R1

FBR1RC3/150 fall arrest device

The FBR1RC3/150 is a combination of a fall arrest device and a rescue lifting device compliant with EN360 and EN1496/B. Its permissible working load is 140kg. The device has a manual winch with lifting and lowering functions. To install on a stand, the appropriate mounting bracket must be attached. The carabiner has a fall indicator and the design does not require a shock absorber.



FBR1RC3/150

+



**MB173DM
Adapter**

+

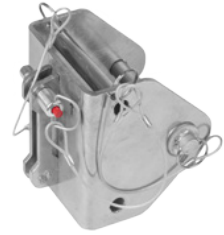

**ZDC0000
Universal Bracket**

Features

- Length of rope /weight 15m/11kg
- Diameter of rope 4.6mm
- Type of rope 7x19 + IWRC
- Mechanism ratio 1:8.8
- Permissible work load: 140kg
- EN 360 EN 1496/B

BLOCKMAX R2

FBR2RC3/250 fall arrest device

The FBR2RC3/250 is a combination of a fall arrest device and a rescue lifting device compliant with EN360 and EN1496/B. Its permissible working load is 140kg. The device has a manual winch with lifting and lowering functions. To install on a stand, the appropriate mounting bracket must be attached. The carabiner has a fall indicator and the design does not require a shock absorber.



FBR2RC3/250

+



**MB171DM
Adapter**

+

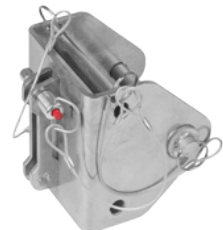

**ZDC0000
Universal Bracket**

Features

- Length of rope /weight 25m/15kg
- Diameter of rope 4.8mm
- Type of rope 7x19 + IWRC
- Mechanism ratio 1:7.4
- Permissible work load: 140kg
- EN 360 EN 1496/B

COMPATIBLE DEVICES

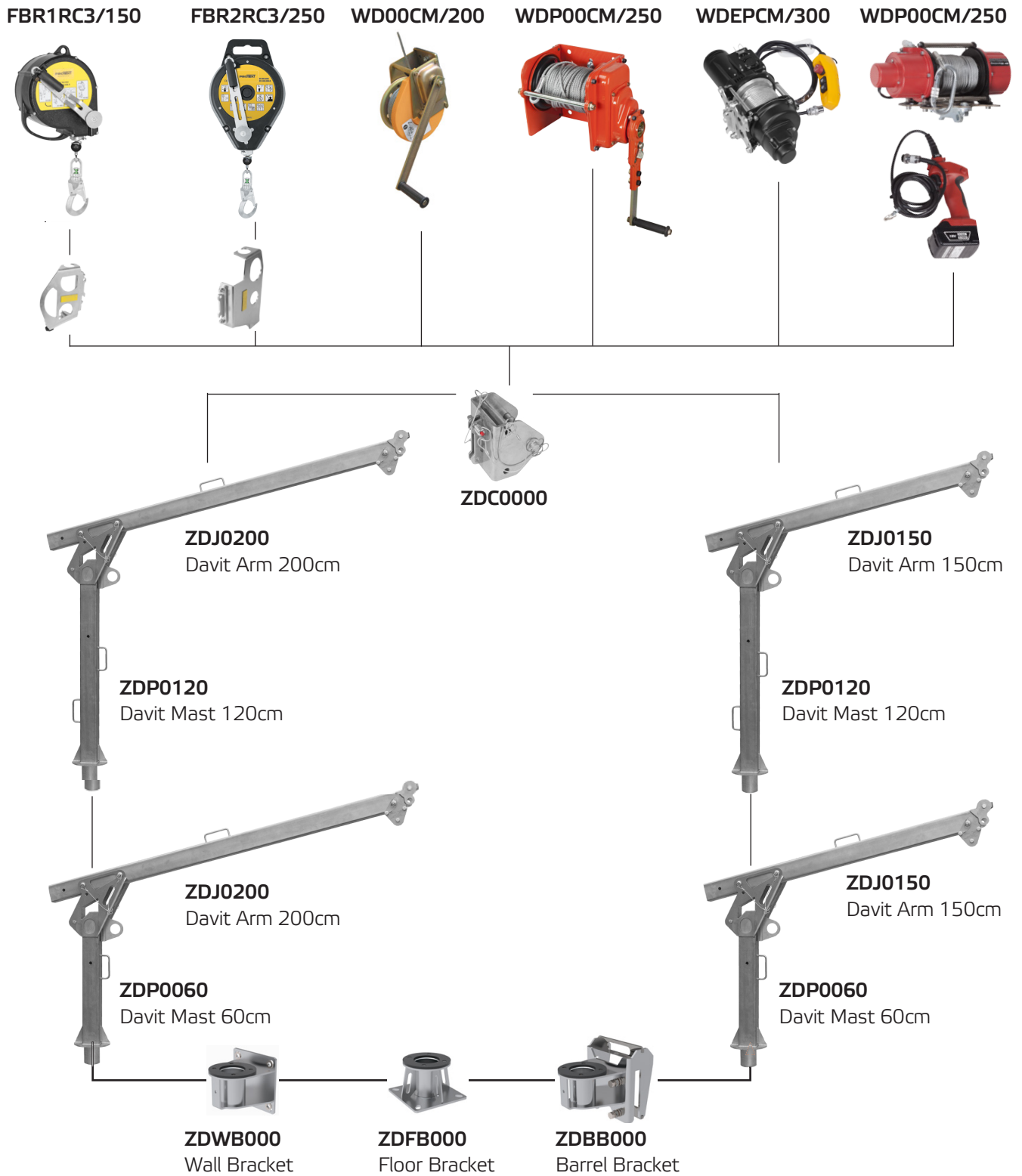



ZERO® TOLERANCE IS ESSENTIAL



CARE MAINTENANCE & INSPECTION

Height Safety and Fall Arrest plans must include proper care and maintenance of all personal protective equipment along with the associated items necessary for a complete fall protection/fall arrest system.

Training sessions related to care and maintenance should be held at regular intervals depending on the nature of the transient work force than for an employer with a mature stable work force.

EN, AS/NZS, OHS, ANSI and OSHA standards require that training is given by a competent, accredited person or training organisation. The user is responsible to be qualified for work at height, ensuring that he/she knows how to properly inspect, use, store and maintain the equipment.

STORAGE

Personal protection equipment (harnesses, lanyards, etc.) along with connectors and other related items should be stored in a clean, dry environment free from direct sunlight, dust, excessive heat and harmful chemicals.

DO NOT put personal protection equipment in clothes dryer or use a blow dryer. Excessive heat may melt the webbing and alter the strength. DO NOT use chemicals to clean heavily soiled gear. Chemicals may destroy webbing, equipment and function.

INSPECTION

All items of equipment which are in regular use shall be subjected to periodic formal inspection (test and tagging) and where applicable, servicing in accordance with the manufacturer's instructions and requirements of AS/NZS 1891.4:2009 and/or EN 365:2004. Where an operator is not competent to carry out this inspection, the inspection shall be carried out by an operator who is competent or a height safety supervisor.



MAINTENANCE/CLEANING

Personal protection equipment should be cleaned periodically using a specialist cleaner or a mild detergent and water. Wash with a soft, non-abrasive brush or sponge and allow to air dry after removing the excess water with a dry cloth.



The inspection shall be carried out in accordance with manufacturer's instructions. Some manufacturer's will only warrant a system/product that has been inspected or repaired by an accredited installer/service agent.

FREQUENCY OF INSPECTION

USER INSPECTION

Personal fall protection/fall arrest systems should be inspected by worker/user, prior to every use. The user should also check all equipment before each use to be sure a formal inspection has been performed within the last six months.

COMPETENT PERSON INSPECTION

All components of personal fall protection/fall arrest systems must be inspected by a competent person at intervals of no more than six months. Inspection reports must be recorded on a formal Inspection Log, and filed for safekeeping.

3 MONTHLY INSPECTION	Fall arrest devices (type 1) Ropes & adjusters/fall arrest devices (Linostop, positioning devices)
6 MONTHLY INSPECTION	Harnesses Lanyards with shock absorbers Retractable webbing lanyards All ropes, finished & cut lengths Shock absorbers Webbing sling anchors, temporary static lines Work positioning lanyards
12 MONTHLY INSPECTION	Anchors, Line & Rail systems Tripods, pulleys, hardware Self retracting lifelines/inertia blocks (type 2 & 3)

For correct use of equipment and fall protection safety, follow these essential safety guidelines

Manufacturer's Instructions	Read and understand the 'Instruction Manual and Fitting Guide' included with the equipment before use.
Training	Ensure this Height Safety equipment is prescribed/fitted/attached according to current government health & safety at work guidelines and that you are adequately trained in its use.
Correct Selection	Always be sure the equipment selected is correct for the purpose intended as advised and selected by qualified & competent persons.
Repairs & Modifications	Do not add to, adapt or repair using components that are not recommended or approved by the manufacturer. Return equipment to manufacturer for servicing.
Certification	All equipment must be recorded, inspected and tagged to current safety guidelines by a competent height safety specialist with the relevant qualifications.
Pre-use Checks	Always check equipment carefully before every use for any deterioration-do not use equipment if there is any deterioration, damage or doubts about its' structural integrity.
Lifespan	Check the label and do not use equipment beyond the manufacturers specified expiry date for safe working lifespan.
Storage	Protect your equipment from dust, dirt and liquids, store in a dry, cool area with good ventilation and away from direct sunlight. Dry any damp gear away from direct sunlight before storage.
Impacted Equipment	Immediately withdraw from use any equipment that has been impacted or been used to arrest a fall.
Rescue Plan	Always prepare a rescue plan for every work site and work undertaken. Never work alone at heights.

Reimagine your boundaries;
we'll get you there.

ZERO HEIGHT SAFETY LIMITED



AUSTRALSIA

10 Holt Place,
Harewood, Christchurch 8053
New Zealand

sales@zeroheightsafety.com

EUROPE & UK

Badenerstrasse 122
5466 Kaiserstuhl,
Switzerland

sales.eu@zeroheightsafety.com

zeroheightsafety.com